



Food Service Technology Center



Encore KLP50-Y002105 Pre-Rinse Spray Valve Test Report

FSTC Report # 501311419-R1

Application of ASTM
Standard Test Method F2324-03 and F2324-13

August 2015

Prepared by:
Andre Hookfin
Fisher-Nickel, Inc.

Prepared for:
Pacific Gas and Electric Company
Customer Energy Efficiency Programs
PO Box 770000
San Francisco, California 94177

Pacific Gas and Electric Company Food Service Technology Center. All rights reserved. © 2015

FSTC Equipment Test Report

Food Service Technology Center Background

The information in this report is based on data generated at the Pacific Gas and Electric Company (PG&E) Food Service Technology Center (FSTC). Dedicated to the advancement of the foodservice industry, The FSTC has focused on the development of standard test methods for commercial foodservice equipment since 1987. The primary component of the FSTC is a 10,000 square-foot laboratory equipped with energy monitoring and data acquisition hardware, 60 linear feet of canopy exhaust hoods integrated with utility distribution systems, equipment setup and storage areas, and a state-of-the-art demonstration and training facility.

The FSTC Energy Efficiency for Foodservice Program is funded by California utility customers and administered by PG&E under the auspices of the California Public Utilities Commission (CPUC). California customers are not obligated to purchase any additional services offered by the contractor.

Policy on the Use of Food Service Technology Center Test Results and Other Related Information

- Fisher-Nickel, Inc. and the FSTC do not endorse particular products or services from any specific manufacturer or service provider.
- The FSTC is *strongly* committed to testing foodservice equipment using the best available scientific techniques and instrumentation.
- The FSTC is neutral as to fuel and energy source. It does not, in any way, encourage or promote the use of any fuel or energy source nor does it endorse any of the equipment tested at the FSTC.
- FSTC test results are made available to the general public through technical research reports and publications and are protected under U.S. and international copyright laws.

Disclaimer

Copyright 2015 Pacific Gas and Electric Company Food Service Technology Center. All rights reserved. Reproduction or distribution of the whole or any part of the contents of this document without written permission of FSTC is prohibited. Results relate only to the item(s) tested. Neither, Fisher-Nickel, Inc., PG&E nor any of their employees, or the FSTC, make any warranty, expressed or implied, or assume any legal liability of responsibility for the accuracy, completeness, or usefulness of any data, information, method, product or process disclosed in this document, or represents that its use will not infringe any privately-owned rights, including but not limited to, patents, trademarks, or copyrights.

Reference to specific products or manufacturers is not an endorsement of that product or manufacturer by Fisher-Nickel, Inc., the FSTC, or PG&E. In no event will Fisher-Nickel, Inc. or PG&E be liable for any special, incidental, consequential, indirect, or similar damages, including but not limited to lost profits, lost market share, lost savings, lost data, increased cost of production, or any other damages arising out of the use of the data or the interpretation of the data presented in this report.

Retention of this consulting firm by PG&E to develop this report does not constitute endorsement by PG&E for any work performed other than that specified in the scope of this project.

Legal Notice

This report was prepared as a result of work sponsored by the California Public Utilities Commission (CPUC). It does not necessarily represent the views of the CPUC, its employees, or the State of California. The CPUC, the State of California, its employees, contractors, and subcontractors make no warranty, express or implied, and assume no legal liability for the information in this report; nor does any party represent that the use of this information will not infringe upon privately owned rights. This report has not been approved or disapproved by the CPUC nor has the CPUC passed upon the accuracy or adequacy of the information in this report.

Revision History

Revision num.	Date	Description	Author(s)
0	Jun 2015	Initial Release	A. Hookfin
1	Aug 2015	Component Hardware to Encore name change; Valve picture correction; Force Gauge Tests	A. Hookfin

FSTC Equipment Test Report

Contents

	Page
Equipment Description	4
Test Location	4
Ventilation	4
Test Instrumentation Inventory	5
FSTC Test Report: Results	6
Additions, Deviations, and Exclusions	8
Manufacturer Specifications Sheet	9
Report Certification	10

FSTC Equipment Test Report

Equipment Description

Test Work Order Number (TWO)	11419
Manufacturer	Encore
Model	KLP50-Y002105
Serial Number	N/A
Generic Equipment Type	Pre-Rinse Spray Valve
Rated Input	1.05 gpm
Construction	Brass/Plastic
Controls	Flow on/off Lever
External Dimensions (W x D x H)	9.5 x 3 x 3
Custom Settings (if any)	N/A

Test Location

All testing was performed under controlled conditions in the FSTC laboratory facilities at 12949 Alcosta Blvd., Suite 101, San Ramon, CA 94583.

Ventilation

Ventilation was not required for this particular test method.

FSTC Equipment Test Report

Test Instrumentation Inventory

Description (ID)	Manufacturer	Model	Measurement Range	Resolution	Calibration Date	Next Calibration
Digital Scale (ALE304)	Acculab	SVI-20B	0 – 44 lb	0.005 lb	08/11/2014	08/11/2015
Digital Timer (ALD210)	Oakton	35002-11	00:00:00 – 99:99:99	0.01 sec	03/08/2013	02/12/2016
Thermometer (ALD402)	Fluke	52	-40 – 500°F	0.1°F	08/11/2014	08/11/2015
Press. Gauge (ALD409)	DU Instruments	42070533	0 – 100 PSI	1 PSI	08/12/2014	08/12/2015
Force Gauge (ALA115)	Mark-10	M3-2 (Series 3)	0.12 – 0.5 ft.lb	0.0005 ft.lb	09/12/2014	09/12/2016

Specifications	
Make	Component Hardware:
Model	CHG KLP50-Y002105
Rated Flow Rate @ 60 psi (gpm)	1.05 GPM

Test Parameters	
Water Pressure	60 ± 2 psi
Water Temperature	120 ± 4°F

Nozzle #1		
Test	Flow Rate (gpm)	Cleanability (seconds)
1	1.10	12
2	1.10	13
3	1.10	12
Average	1.10	12

Nozzle #2		
Test	Flow Rate (gpm)	Cleanability (seconds)
1	1.10	12
2	1.11	12
3	1.10	12
Average	1.10	12

Nozzle #3		
Test	Flow Rate (gpm)	Cleanability (seconds)
1	1.10	12
2	1.10	12
3	1.10	12
Average	1.10	12

Average Results		
	Water Flow (gpm)	Cleanability (seconds)
Nozzle #1	1.10	12
Nozzle #2	1.10	12
Nozzle #3	1.10	12
Average	1.10	12

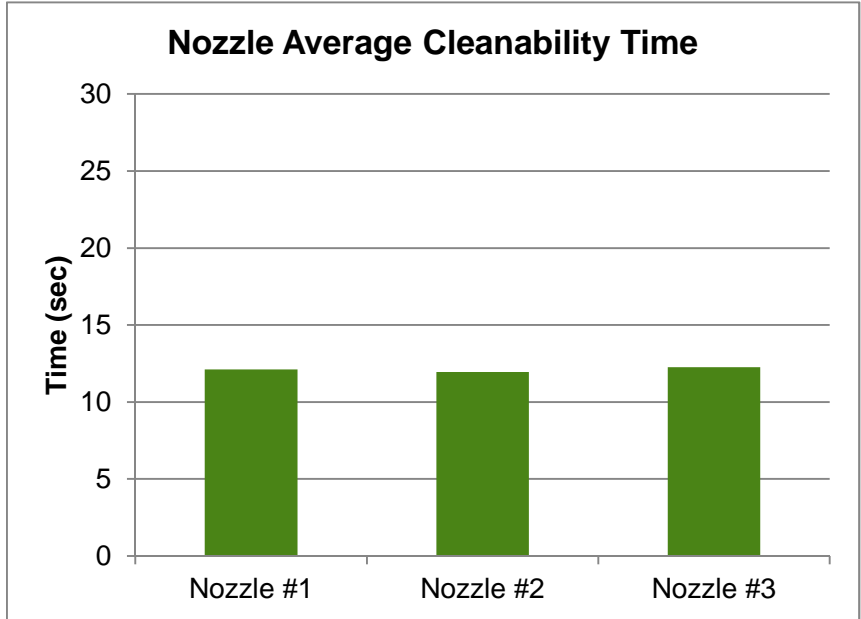
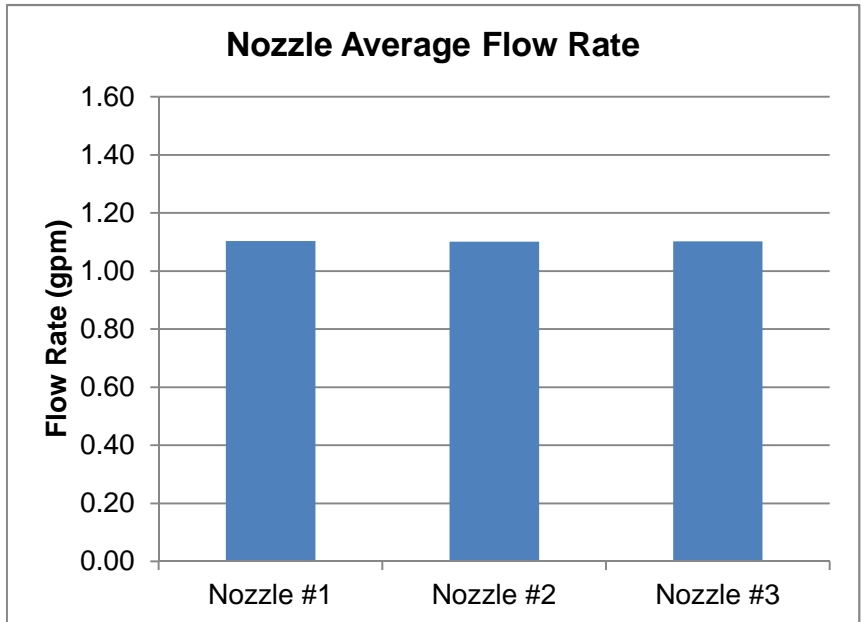

- Tested in accordance with ASTM F2324 - 03 (Standard Test Method for Prerinse Spray Valves)
- Tested nozzles are in compliance with the minimum performance provisions shown in section 1605.3(h) of CA Title 20 Appliance Efficiency Regulation
- Tested nozzles are in compliance with the appropriate marking requirements shown in section 1607 of CA Title 20 Appliance Efficiency

- The Food Service Technology Center program is funded by the California utility customer and administered by the Pacific Gas & Electric Company under the auspices of the California Public Utilities Commission

Specifications	
Make	Encore
Model	CHG KLP50-Y00215
Rated Flow Rate @ 60 psi (gpm)	1.05 GPM

Test Parameters	
Water Pressure	60 ± 2 psi
Water Temperature	120 ± 4°F

Nozzle #1		
Test	Flow Rate (gpm)	Force Results (oz-force)
1	1.10	6.8
2	1.10	6.9
3	1.10	7.0
Average	1.10	6.9

Nozzle #2		
Test	Flow Rate (gpm)	Force Results (oz-force)
1	1.10	7.0
2	1.10	6.9
3	1.10	6.9
Average	1.10	6.9

Nozzle #3		
Test	Flow Rate (gpm)	Force Results (oz-force)
1	1.10	6.8
2	1.10	6.8
3	1.10	6.7
Average	1.10	6.8

Average Results		
	Water Flow (gpm)	Force Results (oz-force)
Nozzle #1	1.10	6.9
Nozzle #2	1.10	6.9
Nozzle #3	1.10	6.8
Average	1.10	6.9

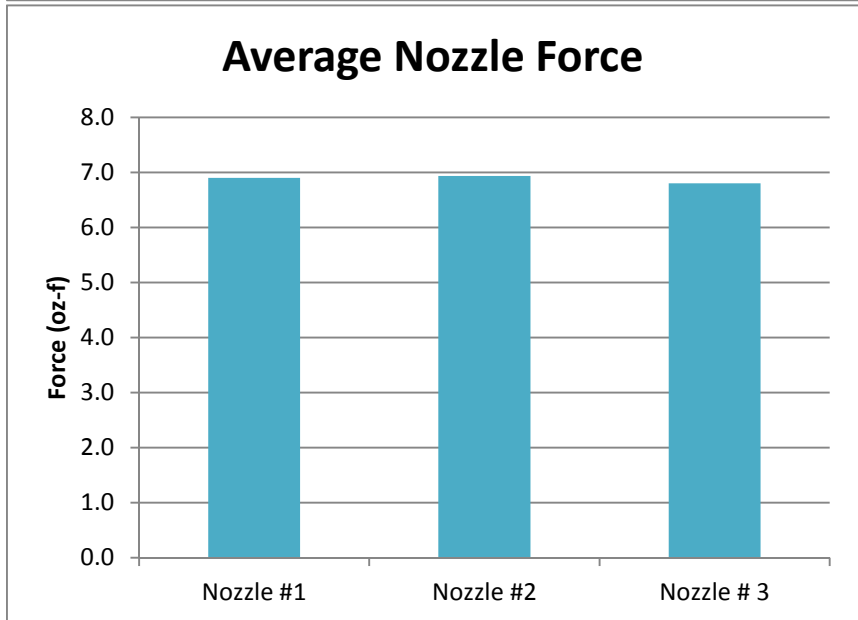
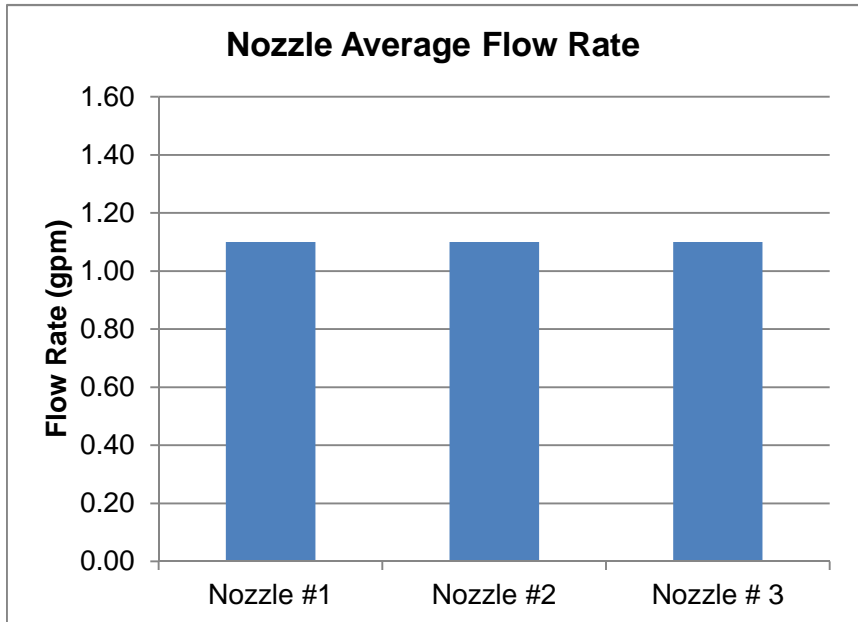

- Tested in accordance with ASTM F2324 - 13 (Standard Test Method for Prerinse Spray Valves)
- Tested nozzles are in compliance with the minimum performance provisions shown in section 1605.3(h) of CA Title 20 Appliance Efficiency Regulation
- Tested nozzles are in compliance with the appropriate marking requirements shown in section 1607 of CA Title 20 Appliance Efficiency

- The Food Service Technology Center program is funded by the California utility customer and administered by the Pacific Gas & Electric Company under the auspices of the California Public Utilities Commission

FSTC Equipment Test Report

Additions, Deviations, & Exclusions

Additions:

None.

Deviations:

None.

Exclusions:

None.

FSTC Equipment Test Report

Manufacturer Specifications Sheet

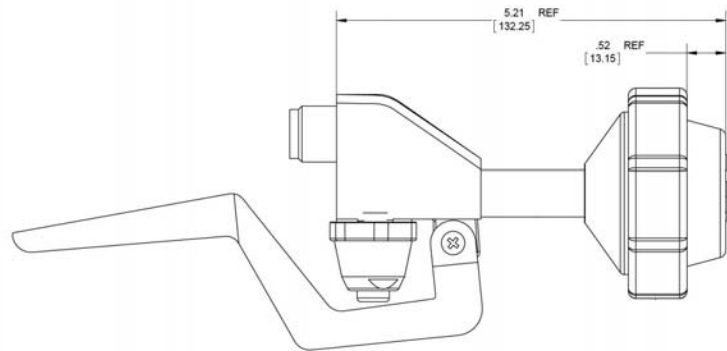

Food Service Technology Center

Addendum: Report Certification

EPA Organization ID: 1113443

This certifies that the undersigned has performed equipment testing according to the methodology outlined in the report described below, and verifies that the results recorded in that report were the actual results observed.

Report: Equipment Test Report: Encore KLP50-Y002105 Pre-Rinse Spray Valve

Report #: 501311419-R1

Date published: August 2015

File name: 15 08 27 501311419 R1.PDF

Date sent for
authorization: 08/27/2015

Tested by:

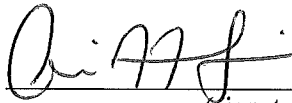

(signature)

Date signed: 8/27/15

Andre Hookfin
(print name)

Lab Technician
(title)

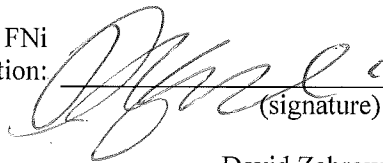
FNi
Authorization:



(signature)

Date signed: 8/27/15

David Zabrowski
(print name)

FSTC General Manager
(title)

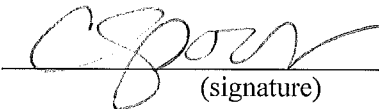
PG&E
Authorization:

(signature)

Date signed: 8/27/2015

Charlene Spoor
(print name)

Senior Program Engineer
(title)